

MODEL 5516DL
OSCILLOSCOPE
INSTRUCTION MANUAL

KIKUSUI ELECTRONICS CORP.

772516

Power Requirements of this Product

Power requirements of this product have been changed and the relevant sections of the Operation Manual should be revised accordingly.

(Revision should be applied to items indicated by a check mark)

Input voltage

The input voltage of this product is _____ VAC,
and the voltage range is _____ to _____ VAC. Use the product within this range only.

Input fuse

The rating of this product's input fuse is _____ A, _____ VAC, and _____.

WARNING

- To avoid electrical shock, always disconnect the AC power cable or turn off the switch on the switchboard before attempting to check or replace the fuse.
- Use a fuse element having a shape, rating, and characteristics suitable for this product. The use of a fuse with a different rating or one that short circuits the fuse holder may result in fire, electric shock, or irreparable damage.

AC power cable

The product is provided with AC power cables described below. If the cable has no power plug, attach a power plug or crimp-style terminals to the cable in accordance with the wire colors specified in the drawing.

WARNING

- The attachment of a power plug or crimp-style terminals must be carried out by qualified personnel.

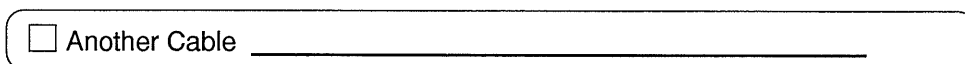
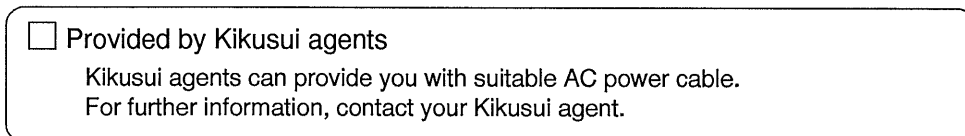
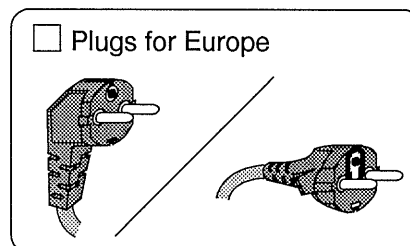
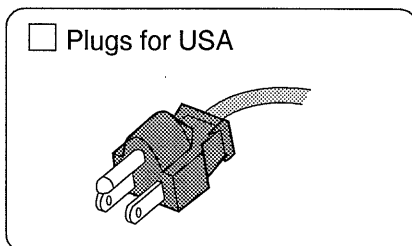
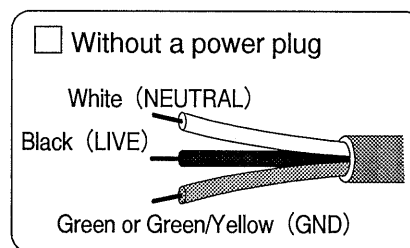
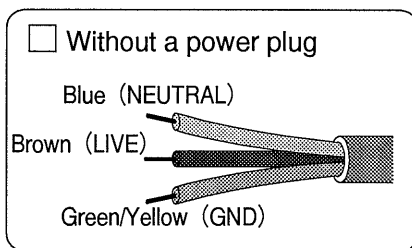

CONTENTS

1.	GENERAL	1
1.1	General	1
1.2	Features	1
1.3	Construction	2
2.	SPECIFICATIONS	3
3.	OPERATION	9
3.1	Explanation of Front Panel	9
3.2	Explanation of Rear Panel	15
3.3	Caution on Operation	16
3.4	Change of Supply Line Voltage	17
4.	OPERATION	18
4.1	Display of Calibration Signal Waveform	19
4.2	Dual Channel Mode and ADD Mode	20
4.3	X - Y Mode	22
4.4	INTEN MOD	23
4.5	Trigger and Time Base	23
4.6	Types of Trigger Signal Source	24
4.6.1	Internal Trigger (NORM, CH1, CH2)	24
4.6.2	External Trigger (EXT TRIGGER IN)	25
4.7	AC and DC	25
4.8	FLAT and HF REJ	25
4.9	LEVEL Knob and " PUSH + " " PUSH - "	26
4.10	COMP AUTO mode	28
4.11	AUTO mode	28
4.12	NORM mode	28
4.13	SINGLE mode	28
4.14	Sweep Magnification (PULL 5X MAG)	29
4.15	Application Method of Vertical Input Signal	29
4.15.1	Using with Coverd Wires	29
4.15.2	Using with Shielded Cable	30
4.15.3	Using with Coaxial Cable	30
4.15.4	Using with Probe	30
4.15.5	Precaution in Using the Probe	31

4.16	Voltage Measurement	32
4.16.1	DC Voltage Measurement	32
4.16.2	AC Voltage Measurement	33
4.16.3	AC Coupling	34
5.	MEASUREMENT	36
5.1	Time Interval Measurement	36
5.2	Pulse Width Measurement	36
5.3	Measurement of Pulse Rise Time and Fall Time.	37
5.4	Frequency Measurement	38
5.5	Phase Difference Measurement	40
6.	CALIBRATION	42
6.1	General	42
6.2	Adjustment and Check of DC Power Supply	42
6.3	Vertical Deflection Sensitivity	44
6.4	VOLTS/DIV Input Capacitance and Phase Characteristics Compensation	45
6.5	Sweep Time	46
6.6	Calibration of Probe	47
6.7	Adjustment of ASTIG and GEOMETRY	48
7.	BLOCK DIAGRAM	49

772518

1. GENERAL

1.1 General

The MODEL 5516DL oscilloscope is a dual-channel triggered sweep type oscilloscope with vertical sensitivity of 5 mV/cm and bandwidth of DC ~ 20 MHz, employing a high bright 133 mm CRT with low distortion.

1.2 Features

o DELAY LINE

As the delay line function is added in the vertical, rise time of a high speed pulse and ecc., can be easily observed.

o Complete Auto Trigger Circuit

Synchronization is easily performed by complete auto trigger circuit which is newly designed trigger circuit.

o A great part of the triggering circuit which is the most important circuit is composed of ICs.

o Selection of Trigger mode

CH1, CH2, NORM and EXTERNAL can be selected as trigger mode. When CH1 or CH2 is selected as trigger mode, the relation of the phase between two channels of vertical amplifier can be observed by one action without change of input connector.

o SINGLE Sweep

Single sweep can be utilized. The applicable fields of the MODEL 5516DL is widen with DC coupling trigger and a single sweep.

o Employment of Push Buttons

Many push buttons are employed for sure setting.

Especially, X-Y operation can be selected by the only pushing.

o CHOP mode or ALT mode is automatically selected.

Switching between CHOP mode and ALT mode for dual-channels operation is linked with the TIME / CM switch of the time axis.

The two traces are displayed in the CHOP mode when the sweep time is slower than 1 msec, but in the ALT mode when the sweep time is 0.5 msec or faster.

- o Maximum sweep speed is 40 ns/DIV (5 x MAG)
High speed pluse signal are easily observed by this high speed sweep together with the excellent performance of the trigger circuit.
- o Bright trace at high sweep speed
When the MODEL 5516DL is operating at a high sweep speed under the AUTO mode, checking inclination of trace lines and 0 volts level when measuring waveforms which must be analyzed with respect to the zero volts level, are performed by setting the input selector to the GND. Bright traces are displayed without flicker on high speed sweep by reformation of the AUTO trigger circuit.
- o Employing of rotation coil
Shift of position of trace by terrestrial magnetism is easily compensated for employing rotation coil.
- o Employing of CRT with high brightness
CRT with high beam transmitivity and sharp beam is employed.

1.3 Construction

The MODEL 5516DL consists of the main unit and accessories as follows.

Main Unit	1
Accessaries	
MODEL 959A BNC (Probes)	2
MODEL 942 terminal adapter	1
Hexagonal wrench (3 mm).....	1
Fuse (Slow blow 1 A)	1
Short bar	1
Instruction manual.....	1

2. SPECIFICATIONS

Vertical Deflection

Item	Specification	Remark
Sensitivity	5mV/DIV ~ 10V/DIV, 11 ranges	1, 2, 5 steps
Sensitivity accuracy	Within $\pm 3\%$ of panel indicated value, with the variable control in CAL'D position.	
Frequency bandwidth	DC: DC ~ 15 MHz AC: 2 Hz ~ 15 MHz	Within -3dB, 50kHz, 8 DIV as reference
	DC: DC ~ 20 MHz AC: 2 Hz ~ 20 MHz	Within -3dB, 50kHz 4 DIV as reference
Continuous sensitivity control	Controllable by 2.5 times or over of panel indicated value.	
Risetime	Approx. 23.3 ns (15 MHz) Approx. 17.5ns (20 MHz)	Calculated value
Input impedance	1 M Ω $\pm 2\%$, 35pF \pm 2 pF	Parallel
Input terminal	BNC type receptacle	
Maximum allowable input voltage	400V at 5mV/DIV range 600V at other ranges	DC + AC peak value 1 kHz or less
Input coupling	AC and DC	
Shift of base line caused by DC offset	Less than 0.2 DIV at 5 mV/DIV range.	Switching input selector from the DC to the GND.
Shift of base line caused by changing range switch	Less than 1 DIV for switching to 5V range from 2 V range.	Setting input selector to the GND.
Linearity	When 4 DIV signal displayed in CRT center is moved fully in effective vertical area, variation of signal in vertical amplitude is within ± 0.2 DIV.	For signal frequency of less than 100 kHz, including CRT linearity.
Common mode rejection ratio	100:1 or over, at 50 kHz.	When sensitivities of CH1 and CH2 are exactly equal.
Interference between two channels	1000:1 or over, as measured at 100kHz and 8 DIV amplitude.	Both CH1 and CH2 are set at 5mV/DIV range in dual mode. Signal corresponding to full effective area is applied to one channel and input of the other channel is terminated with 50 Ω .

772521

Item	Specification		Remarks	
PUSH INV	Polarity of CH2 alone is inverted.			
Operation modes of vertical channels	CH 1	Operation with independent CH1 alone.		
	CH2	Operation with independent CH2 alone.		
	DUAL (auto-matic switching)	ALT	CH1 and CH2 are alternately swept.	ALT sweep for 0.5ms ~ 0.2 μ s.
		CHOP	CH1 and CH2 are switched at approx. 100 kHz.	CHOP switching for 0.5s ~ 1ms. Linked with the TIME/DIV switch.
ADD	CH1 + CH2			
Signal delaying time	About 120ns			

Horizontal Deflection

Item	Specification	Remarks
Sweep time	0.2 μ S/DIV ~ 0.5S/DIV	1-2-5 steps, 20 ranges.
Sweep time accuracy	Within $\pm 3\%$	When the variable control is set in the CAL'D position.
Continuous sweep time control	Controllable by 2.5 times or over of panel indicated value.	
Sweep magnification	5 times	
Magnification error	0.5s/DIV ~ 1 μ s/DIV $\pm 3\%$ 0.5 μ s/DIV, 0.2 μ s/DIV $\pm 5\%$	In addition to sweep time errors.
Position shift caused by magnification	Within ± 1 DIV at CRT center.	

Trigger

Item	Specification		Remarks
Trigger signal source	NORM	Triggered with CH1 and CH2 signal.	
	CH1	Triggered with CH1 signal alone.	
	CH2	Triggered with CH2 signal alone	
	EXT	Triggered external signal.	

Item	Specification	Remarks
Coupling	DC, AC, HF REJECT	
Polarity	"+" and "-"	
Internal trigger sensitivity		The amplitude on the CRT screen.
DC	DC ~ 20MHz 0.3 DIV	
AC	5Hz ~ 20MHz 0.3 DIV	
HF REJECT	DC ~ 50kHz 0.3 DIV	
External trigger sensitivity		
DC	DC ~ 20MHz 200mVp-p	
AC	5Hz ~ 20MHz 200mVp-p	
HF REJECT	DC ~ 50kHz 200mVp-p	
COMP AUTO	The circuit is perfectly triggered, when the amplitude on CRT screen is 0.3 DIV or over for signals of 50Hz or over.	Trigger level knob is controllable. The specified sensitivity is satisfied in every position of the knob.
AUTO	The trigger sensitivity specification is satisfied for signals of 50Hz or over.	When the trigger condition is not satisfied, the trigger circuit free runs automatically.
NORM	The trigger sensitivity specification is satisfied.	When the trigger condition is not made, the trigger circuit is ready to produce a sweep without trace.
SINGLE	Single sweep. The all trigger specification described above are satisfied. The trigger circuit is reset again with the RESET button.	The trigger circuit is ready to produce a sweep until input signal is applied.
External trigger input impedance	Approx. 100k Ω , with 60pF or less.	Parallel
Input terminal	BNC receptacle	
Maximum allowable input voltage	100V (DC + AC peak)	Below 1 kHz

772523

External Sweep amplifier (X - Y)

Item	Specification	Remarks
System	X-Y system: CH1 for X CH2 for Y	X: Horizontal axis Y: Vertical axis
Sensitivity	X 5mV/DIV ~ 10V/DIV Y 5mV/DIV ~ 10V/DIV	X: 11 steps Y: 11 steps
Frequency response	X DC ~ 2MHz Y DC ~ 20MHz	Within - 3 dB Within - 3 dB 4DIV as reference
Input impedance	1 MΩ ± 2% with 35pF ± 2pF (X and Y)	Parallel
Maximum allowable input voltage	5mV/DIV range 400V Other ranges 600V (Both X and Y)	DC + AC peak value below 1 kHz
Input terminal	BNC receptacle (Both X and Y)	Letter X and Y are indicated on panel.

Calibration Voltage

Item	Specification	Remarks
Waveform	Square-wave	
Polarity	Positive	
Output Voltage	50mVp-p and 2Vp-p	
Output Voltage accuracy	Within ± 3%	
Frequency	1 kHz ± 25%	
Duty ratio	45:55 ~ 55:45	
Rise time	Approx. 150 ns	
Output terminal	Chip terminals	

Z axis

Item	Specification	Remarks
Intensity modulation	3Vp-p signal produces noticeable modulation at normal intensity.	
Usable frequency range	DC ~ 1 MHz	
Input resistance	Approx. 10kΩ	
Input terminals	Binding-posts	

772524

CRT

Item	Specification	Remarks
Type	133 mm dia. circular	High brightness
Phosphor	B 31	
Acceleration voltage	Approx. 2000V	
Effective area	8 DIV x 10 DIV	1 DIV \cong 9.5 mm
Trace and graticule alignment	Adjustable by rotation coil. electrically	
Blanking	With G 1	
Illumination	Continuously variable	

Power requirement

Item	Specification	Remarks
Usable supply line voltage	Within $\pm 10\%$ of 100V, 110V, 117V, 200V, 220V, 230V and 240V.	Changeable by taps of power transformer.
Frequency	50 ~ 60 Hz	
Power consumption	Approx. 63 VA.	

Cabinet

Item	Specification	Remarks
External dimensions	245W x 205H x 460D mm 242W x 181H x 400D mm	Maximum dimensions Cabinet dimensions
Weight	Approx. 9.3 kg	Without accessory

772525

3. OPERATION

3.1 Explanation of Front Panel

Function of the knobs, terminal and so on are explained in this section.

Regarding the double-knobs, the function of the black knobs are displayed with black letters, and those of the red knobs are displayed with red letters.

POWER OFF This knob is used in common for both main power on-off control and scale illumination control. The extremely counter-clockwise position is the power off position. Power is turned, when turning it clockwise.

ILLUM This knob is used for control of illumination of CRT screen scale. The screen is brightened with clockwise rotation and vice versa.

INTEN This knob is used for trace brightness control. Trace brightness increases when this knob is turned clockwise, and vice versa.

FOCUS In conjunction with ASTIG control (internal semi-fixed resistor), this knob should be so adjusted that the spot or trace displayed on CRT screen is made most well-defined.

CALLIB(Vp-p) These terminals provide a square-wave signal for sensitivity calibration and probe phase adjustment. Its frequency is approximately 1 kHz, and its output voltage is 50mVp-p and 2Vp-p. The signals are available at the chip terminals on the front panel.

Vertical Deflection

The functions of controls and terminals of CH1 and CH2 are identical. The explanation on CH1 is directly applicable to CH2 also.

CH1 (X) CH2 (Y) These are vertical input terminals and they also used as terminals for X-Y operation input terminal. Terminals are BNC receptacles, and also used when the probe are used.

AC DC This is a push button switch for selection of input coupling of vertical input signal. Input coupling is DC coupling when the button is returned in upper position. On AC coupling, if the input signal includes a DC component, it is blocked, and the AC component alone is measured. On DC coupling, all component of a input signal is measured.

GND When GND terminal is depressed, the input signal is disconnected from the vertical amplifier at the INPUT terminal (BNC type terminal). The amplifier input is connected to the ground. By depressing the GND push button, the zero volts level of the trace displayed on the CRT screen can be readily checked.

VOLTS/DIV The black knob is used for selection of vertical deflection sensitivity, covering 5 mV/DIV to 10V/DIV in 11 ranges. The value of each switch position indicates the voltage sensitivity per 1 DIV of vertical deflection on CRT screen with the variable knob turned to the extremely clockwise position (CAL'D position).

VAR ← ▽ CAL'D This knob is used for continuously variable attenuation of the input signal, and VAR means variable. When the knob is turned to the extremely counterclockwise position, the signal is attenuated to approximately 1/25 . The letters of CAL'D mean that the sensitivity of the vertical amplifier is calibrated for the red knob on CAL'D position, when the red knob is turned fully clockwise.

POSITION ↑↕ This knob is used for vertical positioning of the spot or trace displayed on the CRT screen. When turning it clockwise the spot or trace shifts upward. It shifts downward by counterclockwise rotation.

772528

DC BAL This semi-fixed resistor is used for minimizing trace shift by switching the VOLTS/DIV selector. It is adjusted on 2V/DIV and 5V/DIV.

CAL This is a knob for the calibration of vertical axis. This is used in common for all ranges.

GND (terminal) This terminal is electrically connected to panel, chassis and case. (Both of CH1 and CH2)

POLARITY This push button switch is used for 180 phase inversion of input signal of CH2. The phase is inverted on depressed state.



The function explained above, except GND and POLARITY, are identical for both CH1 and CH2.

MODE This interlocking switch with four units selects the operating modes of amplifiers of CH1 and CH2 as below.

CH1 The vertical amplifier of CH1 operates alone, and the Model 5516DL operates as a single-channel oscilloscope.

CH2 The vertical amplifier of CH2 operates alone, and the MODEL 5516DL operates as a single-channel oscilloscope.

rDUAL₁
CH1 CH2 The vertical amplifier of CH1 or CH2 is operated by switching in the CHOP mode or ALT mode, by pushing both of the button CH1 and CH2, and the MODEL 5516DL operates as a dual channel oscilloscope. The sweep circuit operates in the CHOP mode for ranges from 0.5s/DIV to 1ms/DIV and in the ALT mode for ranges from 0.5mS/DIV to 0.2μs/DIV.

ADD Signals applied to the CH1 OR: X and CH2 OR: Y connectors are algebraically added and this sum is displayed on the CRT. The INVERT switch in Channel 2 allows the display to be CH1 + CH2 or CH1 - CH2.

X-Y This button is used for an external sweep by X-Y system. CH1 operates as X axis (Horizontal), and CH2 operates as Y axis (Vertical). The frequency range of X axis is DC ~ 2MHz, -3 dB.

772529

Horizontal deflection

POSITION

For horizontal positioning of the spot or trace displayed on the CRT screen. It shifts rightward with clockwise turning, and vice versa.

PULL
5X MAG

The POSITION knob is used in common for this function also. As the knob is pulled out, the horizontal amplitude of the trace is magnified by a factor of 5 without shift of the trace. The center of expansion is the center of the graticule. On X-Y operation, the trace is not magnified.

TIME/DIV

A sweep time from 0.5s/DIV to 0.2 μ s/DIV in 20 ranges. The value of each position indicates the sweep time per 1 DIV of horizontal sweep under the state that the variable knob (red) is turned to the extremely clockwise position (CAL'D position).

VAR 

Sweep time is continuously variable by this red knob. The value is varied to approximately 1/2.5, when the knob is turned to the extremely counterclockwise position. The letters of CAL'D means that the sweep time is calibrated on the position that the red knob is turned fully clockwise.

LEVEL



This knob is used for adjustment of trigger level. A point at where the sweep start on the trigger signal waveform is adjusted by this knob. Polarity of trigger level becomes positive when the knob is turned clockwise. It becomes negative by counterclockwise rotation.

PUSH +
PUSH -

This pull-push switch selects a slope of the trigger signal. The same knob is used, for trigger level adjustment. The trigger circuit is triggered on a positive-going slope, when the knob is pushed in the PUSH + state. It is triggered on a negative-going slope, when the knob is pulled in the PULL - state.

772530

- COMP AUTO This push button switch is used for operating the COMPLETE AUTO TRIGGER circuit to be the most noticeable characteristic. If the input trigger signal is 0.3 DIV or over on the CRT screen, or the input voltage to the EXT TRIG IN terminal (BNC receptacle on rear panel) is 200mV or over, the circuit is surely triggered and sweep is synchronized. On this operation mode, as trigger level can be set within a range of 'peak to peak' value, it is possible to set the trigger level to a part measured.
- AUTO A sweep for time base free runs by depressing the push button switch. The trace line is displayed on the CRT screen without any measured signal. The circuit is triggered when a measured signal of 50Hz or over and of an amplitude of 0.3 DIV or over as displayed on the CRT screen is applied.
(If the trigger level is within a range of the level of input signal, sweep is synchronized to a signal measured. A sweep free runs for the input signal level over the trigger level set.)
- NORM A sweep for time base is ready to sweep for no signal measured. A sweep is only produced and synchronized to input signal, when the trigger signal level is a range of 'peak to peak' value of the input signal.
- SINGLE This push button is used for a single sweep. The SINGLE button itself and the other buttons (the COMP AUTO, the AUTO, the NORM) are recovered to the state before depressed by pushing the SINGLE button.
- PUSH TO RESET 'SINGLE' explained before and 'PUSH TO RESET' are an identical switch. A sweep generator circuit is prepared for another single-sweep display by pressing the PUSH TO RESET button again, after one single sweep display have finished.
- READY The time axis is ready to produce a single sweep, when the READY LED lights.

FLAT ■
HF REJ ■

This push button switch is used for selecting the coupling state of trigger signal. A trigger signal from CH1, CH2, NORM and EXT is applied to the input with no modulation. In the HF REJ position, the high frequency component or noise superimposed on the signal measured of approximately 50kHz or over is attenuated before applying to the trigger input by inserting a low pass filter with cut off frequency of approximately 50 kHz.

■ AC
■ DC

This push button switch is used for selecting the coupling state of trigger signal. On the AC position, the DC component is cut off, and triggering is made with the AC component alone. On the DC position, triggering is made with all component including DC component.

┌NORM┐
CH1 CH2 EXT

These push button select the type of trigger signal source as below.

CH1

The measured signal of CH1 alone is used as the trigger signal. When CH2, DUAL or ADD is selected as vertical mode of operation, the signal applied to the CH1 operates as the trigger signal source.

CH2

The measured signal of CH2 alone is used as the trigger signal. When CH1, DUAL or ADD is selected as vertical mode of operation, the signal applied to the CH2 operates as the trigger signal source.

┌NORM┐
CH1 CH2

The CH1 and the CH2 explained above are depressed together, the waveform displayed on the CRT screen operates as the trigger signal source.

This mode is a normal trigger mode.

EXT

A signal applied to the EXT TRIGGER IN terminal operates as the trigger signal source.

770530

3.2 Explanation of Rear Panel

The EXT TRIG IN terminal (BNC type receptacle), the TRACE ROTATION semi-fixed resistor, the Z AXIS IN terminals (Binding-posts), fuse holder, power cord and so on are located on the rear panel.

Some of these names are printed on the rear panel.

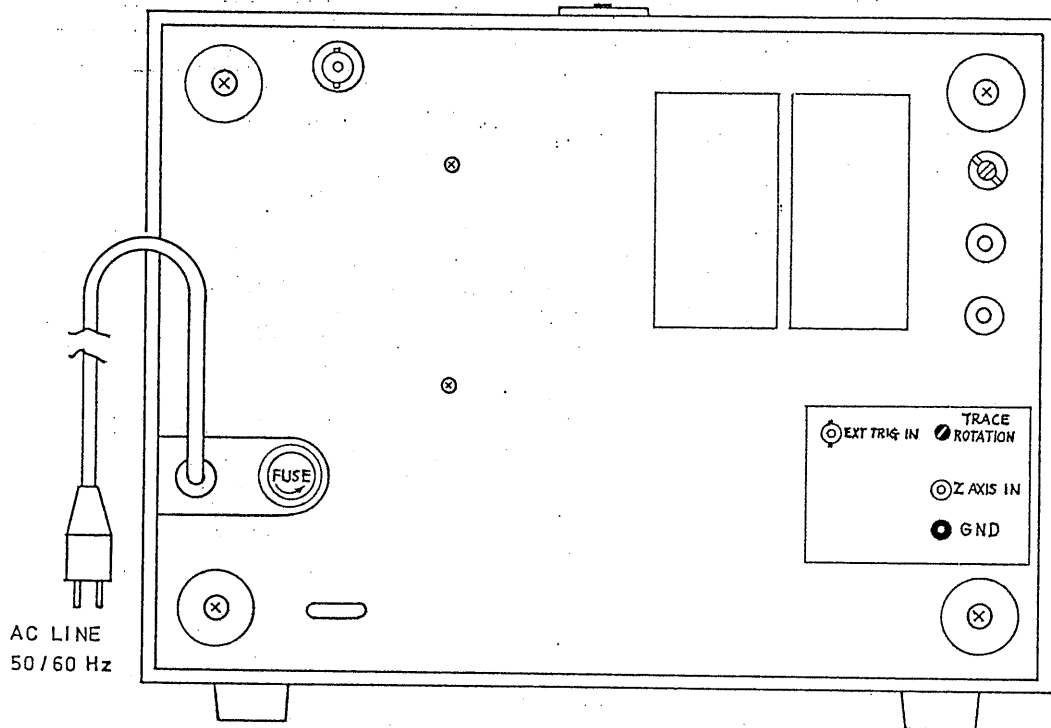

- ⊗ EXT TRIG IN The BNC receptacle for the trigger input from an external signal source.
- ⊙ Z AXIS IN The input terminals for the intensity modulation input from an external signal source. The red terminal is floating side and the black terminal (GND) is grounded. When no intensity modulation is made, the two terminal must be shorted with the short-bar provided as accessory.
- GND
- ⊘ TRACE ROTATION The semi-fixed resistor to align trace with horizontal graticule lines.
- FUSE Fuse holder. The fuse is 1 ampere slow blow type, and is removable by turning the cap counterclockwise.
- AC LINE Power cord. The plug must be connected to power line of the specified voltage.

779533

DL

3.3 Caution on Operation

- Supply line voltage The MODEL 5516DL can be operated safely under the fluctuating range of the specified voltage within $\pm 10\%$ in the specified supply line voltage.
If it is operated with the line voltage over $\pm 10\%$ of the specified voltage, malfunctioning or damage may result. Operate the MODEL 5516DL with the range of the voltage within $\pm 10\%$ in the specified supply line voltage with an appropriate means.
- Ambient temperature The ambient temperature range for normal operation is $0^{\circ}\text{C} \sim 40^{\circ}\text{C}$.
- Environments If the MODEL 5516DL is operated for long period in high temperature and high humidity, troubles may be caused and the life may be shortened. Strong magnetic field or electromagnetic field also affects the measurement with the oscilloscope.
- Brightness of the CRT Do not make the trace excessively bright or do not leave a stationary spot for long period on the screen. The life may be shortened with such an operation.
- Allowable voltage to the input terminal The allowable maximum input voltage to the each input terminal and each probe are shown in the below table.
If a voltage exceeding the specified value is applied, the MODEL 5516DL may be damaged.

The CH1 terminal and the CH2 terminal 5 mV range of VOLTS/DIV Other ranges of VOLTS/DIV	400V (DC + ACpeak) 600V (DC + ACpeak)
Probe (959A BNC)	600V (DC + ACpeak)
EXT TRIG IN terminal	100V (DC + ACpeak)
Z AXIS IN terminal	100V (DC + ACpeak)

For the signal of the frequency of 1 kHz or below.

3.4 Change of Supply Line Voltage

Input line voltage is changeable, as some taps of transformer are provided for operation with line voltage exceeding 100V.

As an AC plug can be used with line voltage of 125V or below, it must be alternated to an appropriate with line voltage of 125V or over.

Use a fuse shown in following Table.

AC (V)	Fuse (A)	Note
90 ~ 110	1	Slow blow
100 ~ 120		
105 ~ 129		
180 ~ 220	0.5	
200 ~ 240		
210 ~ 258		

772535

4. OPERATION

Before turning on the power, set the controls on the front panel as follows.

ILLUM, POWER OFF and INTEN		Fully counterclockwise position.
FOCUS		Approximately center.
MODE		The CH1 is depressed.
Trigger	LEVEL	Approximately center.
	FLAT HF REJ	FLAT
	AC DC	AC
	CH1 CH2 NORM EXT	CH1
	COMP AUTO AUTO NORM SINGLE	AUTO
TIME/DIV		0.2 mS
POSITION (Horizontal)		Approximately center.
CH1	POSITION (Vertical)	Approximately center.
	VOLTS /DIV	0.2V (Red knob is in the CAL'D position.)
	AC DC	DC
	GND	The GND is depressed.

Connect the power cord to a power line receptacle of the specified voltage, and turn clockwise the ILLUM knob from the POWER OFF position.

The power switch clicks, and the power is supplied to the MODEL 5516. The LED indicator located on the upper left of the front panel turn on.

In some ten seconds later, turn further the INTEN knob clockwise until the trace is displayed with an appropriate brightness.

Focus Adjustment

Move the trace to the center of the CRT screen by adjusting the POSITION of the CH1 and the horizontal POSITION knobs.

Adjust the FOCUS knob for the sharpest and the most well-defined display.

772534



4.1 Display of Calibration Signal Waveform

Display on the CRT screen the square wave calibration signal of the MODEL 5516DL (the CALIB terminal) by connecting the BNC terminal adaptor (supplied) to the input terminal of the CH1 and using as short lead cable as possible. (Use 50mV terminal of the CALIB)

Set the controls of the front panel as follows.

AC	DC (CH1)	DC
GND	(CH1)	No depressed state
VOLTS/DIV (CH1)		10 mV
VAR CAL'D (CH1)		CAL'D
TIME/DIV		0.2 mS
VAR CAL'D		CAL'D
The other knobs		The position explained before

When the above setting is made, the square wave with an amplitude of 5 DIV is displayed on the CRT screen.

CALIB
(Vp-p)  2V  50mV

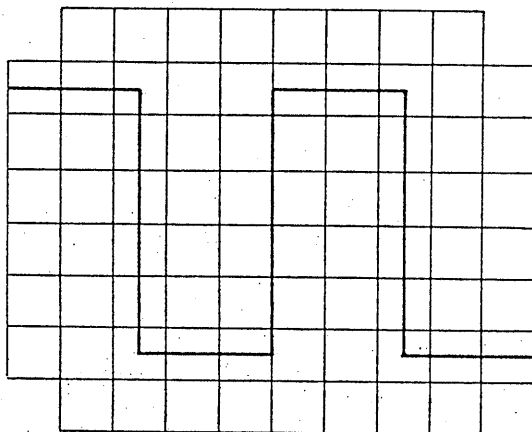

Turn the VOLTS/DIV knob by step counterclockwise. The vertical amplitude of the displayed waveform is reduced correspondingly. The amplitude is continuously reduced as the variable knob is turned counterclockwise. Thus, the functions of the VOLTS /DIV switch and variable control on the input signal can be ensured.

772537

4.2 Dual Channel Mode and ADD Mode

Dual Channel Mode

Set the MODE switch in the DUAL state. (Both of CH1 and the CH2 together.) In the above operating state, the calibration voltage was applied to the CH1 but not the CH2. Now, apply the calibration voltage to the CH2 also. (50mV)

Triggering must be made with the signal applied to the CH1.

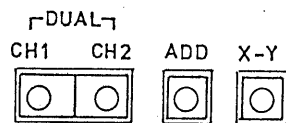

MODE

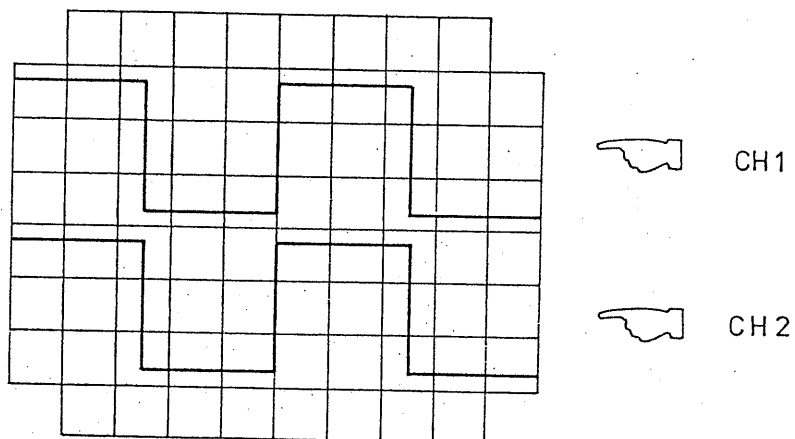

If CH2 signal is synchronizable with respect to CH1 signal, both signal are displayed as stationary waveforms on the CRT screen.

4.3 X-Y Mode

Depress the X-Y button of the MODE selector. By this operation, the CH1 is set for X axis, and the CH2 is set for Y axis.

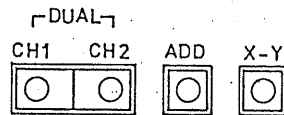

MODE

The electrical characteristics of the Y axis in this case is the same with that of CH2. That of the X axis, however, becomes such that the frequency range is DC ~ 2MHz for -3dB, and the variable control and the POSITION control of the CH1.

Trace shift in the X-Y operation becomes faster than the case of the normal operation. Other electrical performance is the same with that of CH1.

Apply the calibration voltage signal to both X and Y axis.

Adjust the VOLTS/DIV switch of both channels so that appropriate amplitude is obtained and two spots are displayed on the diagonal line of the CRT screen. When this is done, a Lissajou's figure for frequency ratio 1:1 and phase angle difference zero or almost zero is displayed on the screen.

Under the X-Y mode also, the 5X MAG function which is linked with the horizontal POSITION knob remains idle.

772540

4.4 INTEN MOD

The INTEN MOD terminals which accept an external intensity modulation signal is located on the rear panel. For intensity modulation, remove the short-bar, and apply the signal between the red terminal and the black terminal. When no intensity modulation is made, the two terminals must be connected with the short-bar.

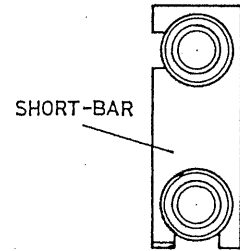

4.5 Trigger and Time Axis

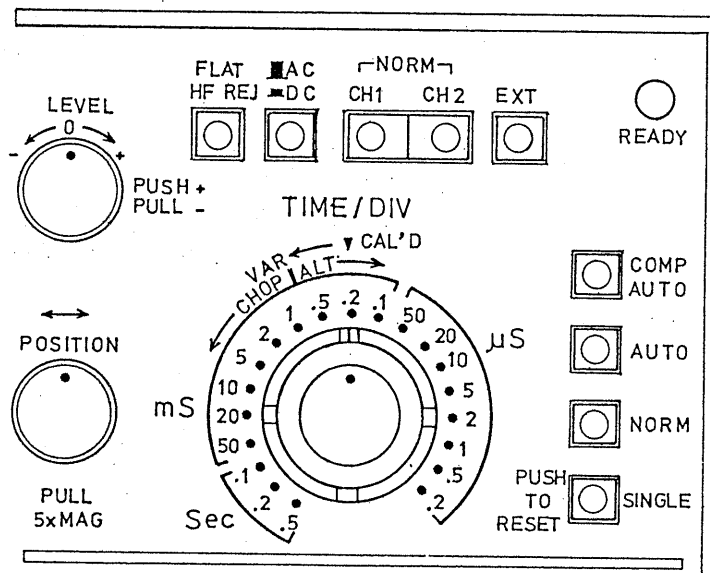

This calibration voltage signal is a square wave of approximately 1 kHz. When the TIME/DIV switch is set in the 0.2 mS position, one repetition of the square wave is displayed with a horizontal amplitude of approximately 5 DIV.

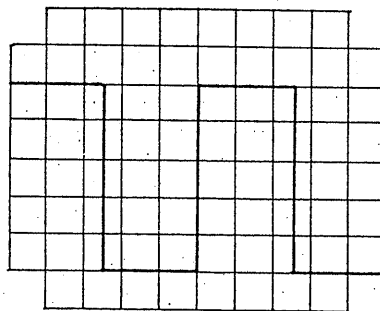

As the TIME/DIV switch is turned clockwise, the sweep time becomes faster and vice versa. The sweep time is continuously adjustable with the variable knob.

772541

4.6 Type of Trigger Signal Source

To display the measured signal as a stationary waveform on the CRT screen, a trigger signal which is synchronized with the measured signal must be applied to the trigger circuit so that the sweeps of the time axis are initiated in synchronization with the measured signal.

There are four types of trigger signal sources. They are the NORM mode (Triggered by displayed signal on the CRT screen.), the CH1 mode (Triggered by the CH1 signal.), the CH2 mode (Triggered by the CH2 signal.) and the EXT mode (Triggered by an external signal applied through the EXT TRIG IN terminal on rear panel.).

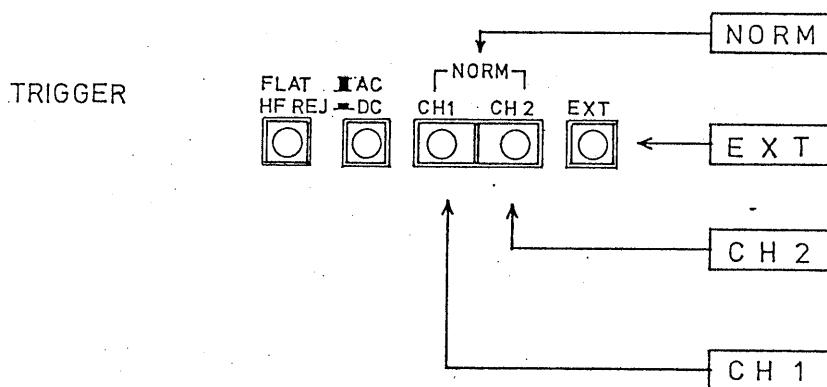

4.6.1 Internal Trigger (NORM, CH1, CH2)

Under the internal trigger, the measured input signal is picked up as a trigger signal at a certain point in the vertical amplifier, and applied to the trigger circuit after the signal is amplified to an appropriate level by the trigger amplifier. Under the NORM mode, the trigger signal is the waveform (CH1 and CH2) displayed on the CRT screen. Under the CH1 mode, the trigger signal is the only input signal to the CH1.

Under the CH2 mode, the input signal to the CH1 is the only trigger signal. When the signal of the CH1 is synchronized with the signal of the CH2, the waveform of the CH2 can be observed with triggering by the signal to the CH1, and vice versa.

772542

DL

4.6.2 External Trigger (EXT TRIG IN)

Under the EXT trigger mode, the trigger circuit can be directly driven without effects which could be caused by the vertical amplifier. For example, under the internal trigger mode, when the VOLTS/DIV switch or the vertical POSITION knob is turned, the voltage applied to the trigger circuit is affected, and the triggering may become unstable for some input signal waveforms.

Under the external trigger mode, the trigger circuit is stably driven irrespective of turning of any controls of the vertical amplifier circuit so far as they do not affect the external trigger circuit. As for the external trigger signal, a signal of less than approximately 10Vp-p must be used.

4.7 AC and DC

The triggering method of the MODEL 5516DL is widely utilized for many use, because DC coupling can be selected for the coupling of the trigger input. Especially, it is available for the trigger signal of DC ~ 5kHz or single sweep. AC coupling is used for general purpose such as the trigger signal of 5Hz ~ 20MHz or the trigger signal with DC component.

4.8 FLAT and HF REJ

Under the HF REJ mode, a low pass filter with a cut off frequency of approximately 50kHz, -3dB, is inserted before the trigger input circuit.

This mode switch is utilized, when the obstructive high frequency component or noise which are superimposed on the original trigger signal is included.

Under the dual-channel mode operation, the TIME/DIV is set in the CHOP mode, the jitter of synchronization may be reduced.

Waveform with a high frequency component (higher than 50kHz) superimposed on the original signal.

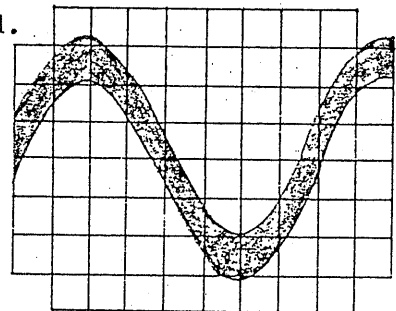

Under the FLAT mode, the stable triggering is always made for the trigger signal of a range of DC ~ 20MHz.

4.9 LEVEL knob and 'PUSH + , PUSH - '

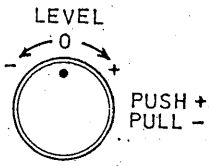

Apply a sine wave or triangle wave signal of approximately 1 kHz to the CH1 input signal. (Adjust the level of the input signal or the vertical variable attenuator so that waveform more than 6 DIV is displayed on the CRT screen.)

Setting of the controls are shown as follows.

FLAT HF REJ FLAT
 AC DC AC
 CH1 CH2 NORM EXT CH1
 TIME/DIV 0.2mS/DIV
 COMP AUTO, AUTO, NORM, SINGLE...AUTO

The display on the CRT screen free runs on the fully counterclockwise position of the LEVEL control. The display is synchronized at the certain position with turning gradually the LEVEL control clockwise.

The start point of the display shift from lower position to upper position, and the display free runs again.

The display is observed in inverse order explained above on the CRT screen with turning the LEVEL knob counterclockwise.

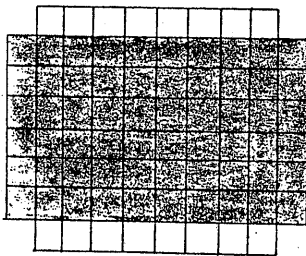

(a) free run

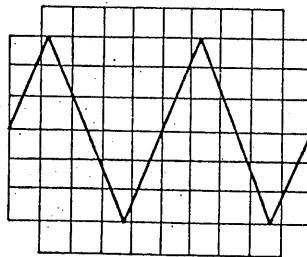

(b) synchronised

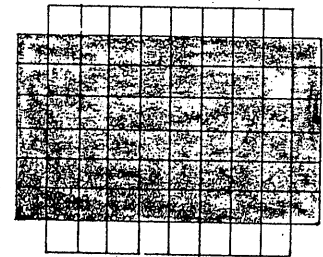

(c) free run

7705AN

The displayed waveform shifts from right to left on the stable display with turning the LEVEL knob clockwise (The position does not shift, and the phase shifts.), and the start point of the display shifts from lower position to upper position.

(the shift of trigger level)

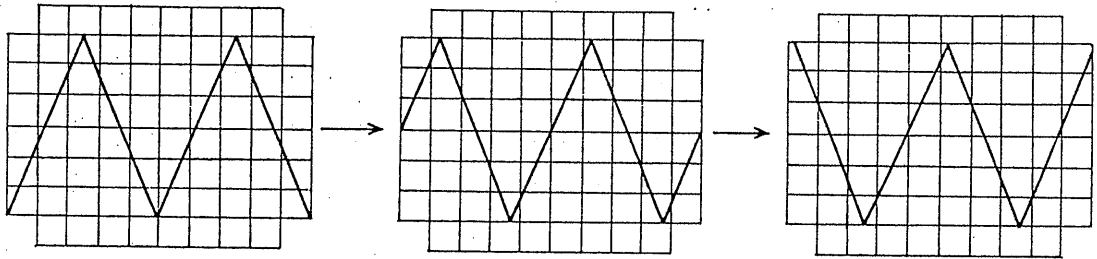

Pull the LEVEL knob. The slope of the start point of the display becomes inverse. It means that trigger is made in the negative-going portion.

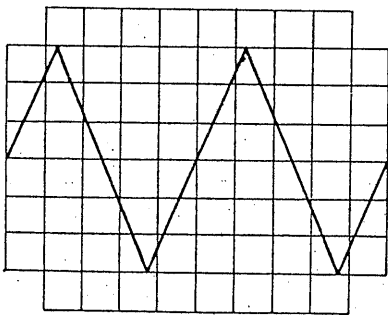

PUSH +

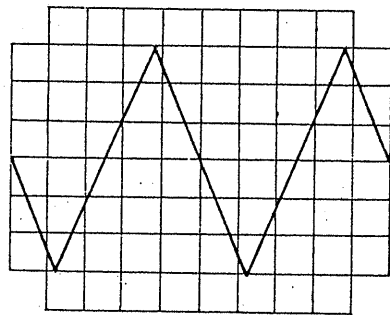

PULL -

7705 AR

4.10 COMP AUTO mode

Set the MODE selector in the COMP AUTO. Adjust the VOLTS/DIV knob and the variable control so that a waveform is displayed with an amplitude of approximately 0.3 DIV. The attenuated stationary display is obtained. (The display is visible with setting the TIME/DIV knob to 1mS/DIV.) The stationary display is obtained for an amplitude of 8 DIV or more.

4.11 AUTO mode

Under the AUTO mode, the time axis is automatically swept even when no trigger input signal is being applied. A bright trace is displayed even at fast sweep ranges and the zero level can be readily checked.

4.12 NORM mode

Under the NORM mode, the time axis in the stand-by state and the traces disappears from the CRT screen when no trigger signal is being applied, the level of the input signal to the EXT TRIG IN terminal is less than 200mVp-p, or when the LEVEL control is turned exceeding the triggering point.

4.13 SINGLE mode

Operate as following procedure for a single sweep.

- (A) Apply a repetitive waveform to the CH1 or the CH2 input, and set the MODE selector in the NORM mode. Display the stationary waveform on the CRT screen by adjusting the trigger level LEVEL control.
- (B) Set the MODE selector in the SINGLE mode.
- (C) Remove the signal from the input terminal.
- (D) Push the SINGLE switch again. (PUSH TO RESET operation)
- (E) The READY LED indicator lights and the time axis is in the stand-by state, When a finger is taken off from the button and the button is turned back.
- (E) Again apply the signal measured to the input. A sweep is triggered by the signal, and a single trace is presented with a single sweep. The READY LED indicator light goes out. The time axis is not operated again, until the SINGLE button is pressed again.

77254

4.14 Sweep Magnification (PULL 5 X MAG)

When a particular section of the input signal is required to be expanded for detailed observation, the requirement may be met by using a fast sweep speed. However, if the required section is located apart from the starting point of the sweep, the required section may run out of the viewing screen. In such a case, pull out the POSITION knob (set in the 5 X MAG state). The required section is horizontally expanded by a factor of 5 from the screen center.

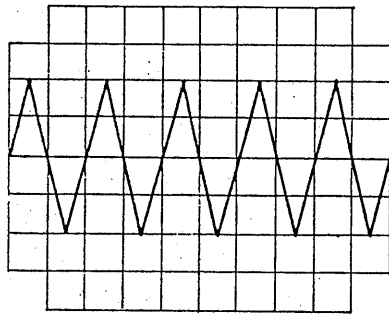

(a) Before magnifier

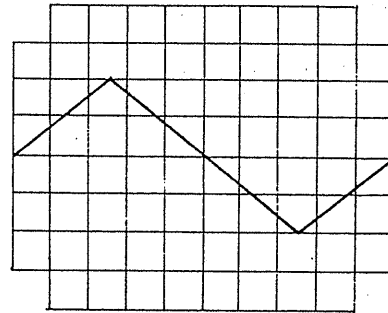

(b) After magnifier

When the 5xMAG function is affected, the sweep time becomes as below.

$$(\text{TIME/DIV indication}) \times 1/5 = \text{Sweep time} / \text{DIV}$$

When the sweep is magnified, the trace brightness is reduced. The use of the sweep magnification should be limited to the below cases.

- (1) When a particular section which is located apart from the sweep start point is required to be magnified for observation of details.
- (2) When a sweep time of faster than $0.2\mu\text{s}/\text{DIV}$ is required.

4.15 Application method of Vertical Input Signal

4.15.1 Using with Covered Wires

Attach the BNC terminal adaptor (supplied) to the vertical input terminal , and apply the input signal through the covered wires. Note, however, that measurement under this method may be unstable because the input wire are susceptible to induction noise interference when they are long or when the input signal source impedance is high. The displayed characteristics may be affected because the stray capacitance with respect to the ground is large. As compared with the case the 10:1 probe is used, this method is susceptible to mutual interference with the measured circuit and other undesirable effects.

4.15.2 Using with Shielded Cable

By the use of a shielded cable, external noise introduced in the input connection can be eliminated. However, the use of a shielded cable is disadvantageous in that the capacitance between signal source and ground become large ($50 \text{ pF/m} \sim 100 \text{ pF/m}$) and, therefore, the use is not suitable for input connection when the signal source impedance is substantially high or when a signal which includes higher frequency components is to be measured.

4.15.3 Using with Coaxial Cable

When the signal source impedance is 50Ω or 75Ω , a coaxial cable of the matched impedance may be used for input signal connection. When an impedance-matched coaxial cable is used, the input signal can be connected without attenuation for higher frequency components also. Impedance matching can be accomplished by connecting a pure resistance "R" of 50Ω or 75Ω corresponding to the characteristic impedance of the cable, in the input side of the oscilloscope as illustrated below.

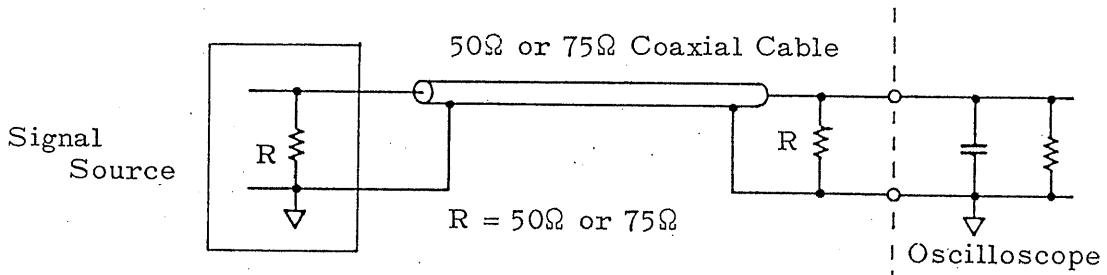
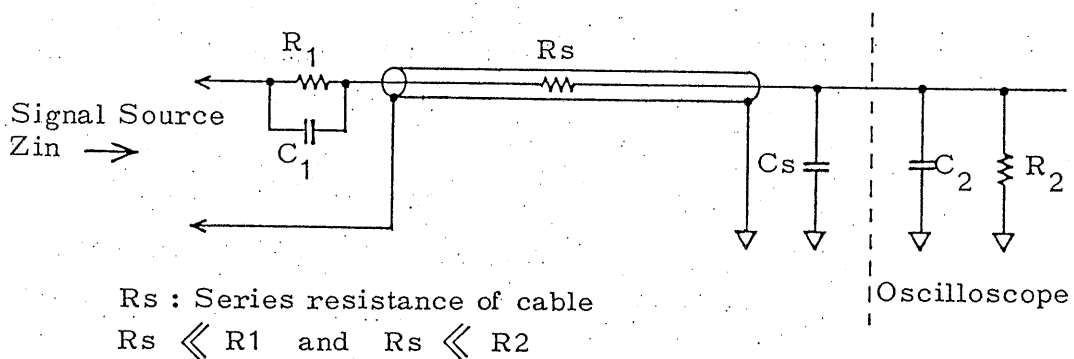

Fig. A

4.15.4 Using with Probe

The input signal can be applied through the 10:1 probe which is supplied as an accessory of the oscilloscope. The probe provides electrical shielding from the oscilloscope to the probe, and eliminates external noise.



7795A8

DL

$$Z_{in} = \frac{R1 + R2}{\omega C (R1 + R2) + 1}$$

$$C = \frac{C1 \times (C2 + Cs)}{C1 + C2 + Cs}$$

$$Cs = (\text{Stray capacitance}) + (\text{Cable capacitance})$$

Attenuation resistor R1 and its parallel capacitor C1 make up a wide-band attenuator which minimizes the loading effect on the measured signal source when the signal source impedance is high and which is suitable for measurement of signals which include higher frequency components. The attenuation ratio is 10:1 as expressed by below equation.

$$\text{Attenuation ratio: } \frac{R2}{R1 + R2} = \frac{1M\Omega}{9M\Omega + 1M\Omega} = \frac{1}{10}$$

The purpose of the circuit is not to divide the voltage level to 1/10 but is to reduce the loading effect on the measured signal source.

4.15.5 Precaution in Using the Probe

- (1) The specified maximum allowable input voltage must not be exceeded.
- (2) The accessory ground wires must be connected when the oscilloscope is used at a high sensitivity for a wide frequency range. Both of them must be connected also when the oscilloscope is used in dual channel mode.
- (3) The phase of the probe must be accurately calibrated. The probe supplied as an accessory of the MODEL 5516DL must be used.
- (4) The probe must be protected against abnormally large mechanical shock, vibration, bent and pull.
- (5) The main body and tip of the probe is not highly heat resistant.

Do not make soldering near the probe under the state that the lead wire is being connected to the probe.

4.16 Voltage Measurement

4.16.1 DC Voltage measurement

- (1) Set the MODE selector in the AUTO mode and the time axis in the free running mode, and display a trace by setting the TIME/DIV switch at a position approximately 1 mS/DIV.
- (2) Set the input coupling selector of the vertical input in the GND state. The trace position under this state is corresponding to zero volts level. By turning the POSITION control, move the trace to a position where is convenient for waveform observation.
- (3) Set the input coupling selector in the DC state. Apply the measured voltage to the vertical input terminal, and measure the movement of the trace on the CRT screen.
- (4) If the trace is deflected off the CRT screen when the measured voltage is applied to the input terminal, turn the VOLTS/DIV switch counter-clockwise to a position where an appropriate deflection on the CRT screen in response to application of the measured signal is obtained.
- (5) If the trace is moved upward, the polarity of the measured signal is positive; if the trace is moved downward, the polarity of the measured signal is negative.
- (6) The measurement may be with the variable knob turned to the extremely clockwise position (CAL'D position) where the voltage sensitivity per 1 DIV on graticule is calibrated and quantitative measurement of the measured signal voltage can be easily made as below.

* When the measured signal is directly applied to the input terminal:

$$\text{voltage } V = (\text{VOLTS/DIV indication}) \times (\text{deflection amplitude in DIV})$$

* When the 10:1 probe is used:

$$\text{voltage } V = (\text{VOLTS/DIV indication}) \times (\text{deflection amplitude in DIV}) \times 10$$

772550

4.16.2 AC Voltage Measurement

Regarding measurement if an AC component superimposed on a DC component, if measurement is made with the input coupling selector set in the DC state and if the DC component is sufficiently large as compared with the AC component, the trace will be deflected off the CRT screen and the AC component will disappear. It may be possible to move the trace of the AC component back on to the CRT screen by turning the vertical POSITION control. Another method of bringing the waveform of the AC component on to the CRT screen is to turn the VOLTS/DIV switch to a lower sensitivity position. The most effective and generally practiced method, however, is to set the input coupling selector in the AC state so that the DC component is cut off and the AC component alone is displayed with appropriate amplitude on the CRT screen.

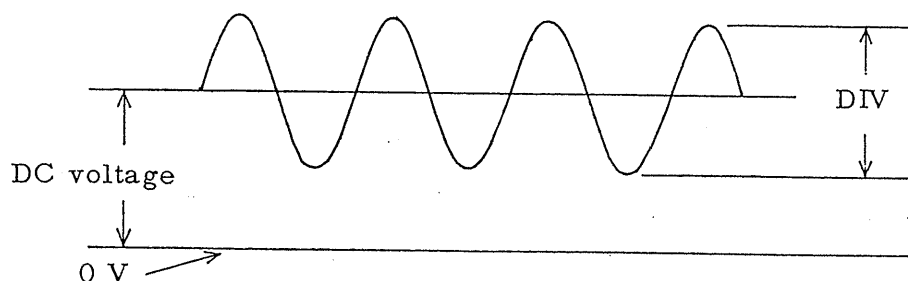

In the AC measurement, the voltage (V_{p-p}) is calculated as below.

$$\text{voltage } V_{p-p} = (\text{VOLTS/DIV indication}) \times (\text{deflection amplitude in DIV})$$

When the 10:1 probe used, the voltage (V_{p-p}) is calculated as below.

$$\text{voltage } V_{p-p} = (\text{VOLTS/DIV indication}) \times (\text{deflection amplitude in DIV}) \times 10$$

The rms value of a sine wave can be calculated from the peak-to-peak value as below.

$$V_{\text{rms}} = \frac{V_{p-p}}{2\sqrt{2}}$$

DL

4.16.3 AC Coupling

As explained in the above, an AC voltage superimposed on a DC voltage is measured in the AC coupling mode. With the AC coupling, however, when the frequency of the measured signal is less than 1kHz, attention must be paid to phase lead and lag and to amplitude reduction. Especially in the case of a square wave of repetition frequency of less than 1kHz, the waveform may be distorted with sag as illustrated below.

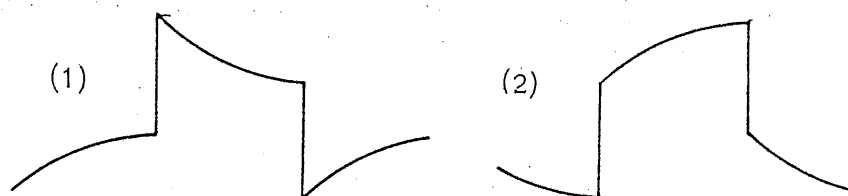

Waveform (1) indicates typical sag which is caused when the phase is leading and the amplitude is attenuated.

Waveform (2) indicates typical sag which is caused when the phase is lagging and the amplitude is attenuated.

From the viewpoint of waveform fidelity, the DC coupling is ideal because it causes no variation either in phase or amplitude.

The input impedance of the MODE 5516DL is $1\text{ M}\Omega$, with a coupling capacitor of $0.1\mu\text{F}$. When a low frequency square wave of a stepwise voltage is applied, sag similar to that indicated with waveform (1) is caused.

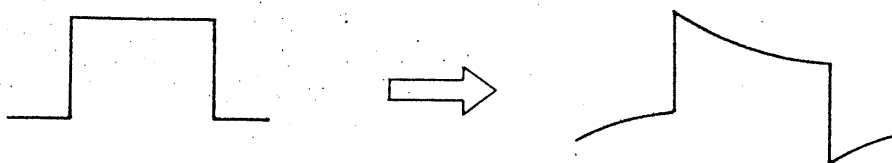
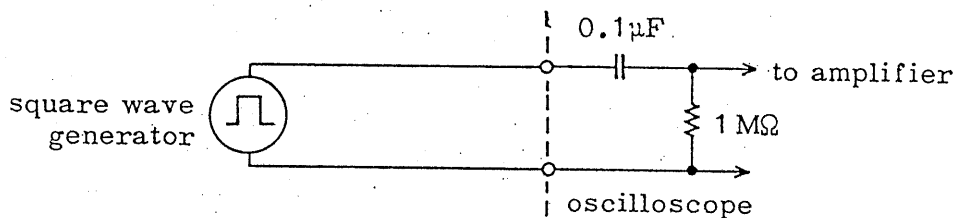

The percentage of sag is calculated as below.

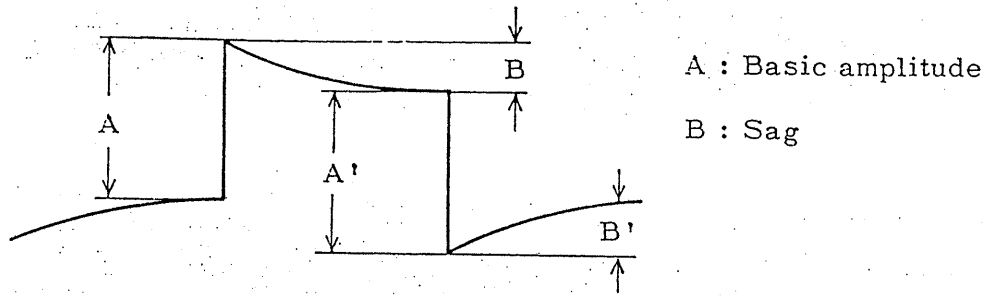

$$\text{Sag} (\%) = \frac{B}{A} \times 100 \quad \text{or} \quad \text{Sag} (\%) = \frac{B'}{A'} \times 100$$

The degree of the MODEL 5516DL is tabulated below.

Repetition Frequency	Sag(%)
10Hz	26
50"	4
100"	2
500"	0.6

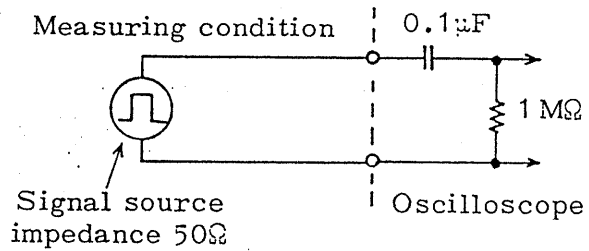

The degree of sag when the 10:1 probe is used is as tabulated below.

Repetition Frequency	Sag (%)
10Hz	2.6
50"	0.4
100"	0.2
500"	0.06

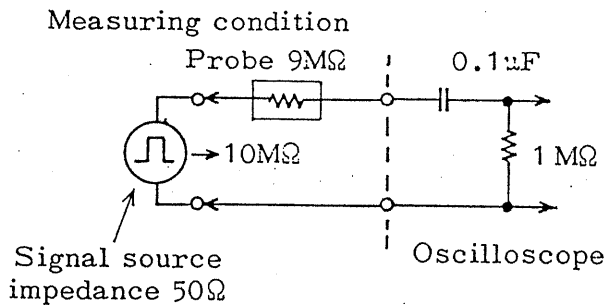

As the value can be seen in the above tables, the degree of sag is reduced to approximately 1/10 when the 10:1 probe is used as compared with the case the input is directly applied to the MODEL 5516DL of which input impedance is 1 MΩ.

It must be noted, however, that the input signal voltage is reduced to 1/10 when the probe is used.

The 10:1 probe can be effectively used when the DC coupling cannot be used and yet observation of waveform with minimum sag is required.

5. MEASUREMENT

5.1 Time Interval Measurement

The time interval between two points on the displayed waveform can be measured by reading value of 'T' referring to the TIME/DIV indication with the variable control of the TIME/DIV switch turned to the CAL'D position

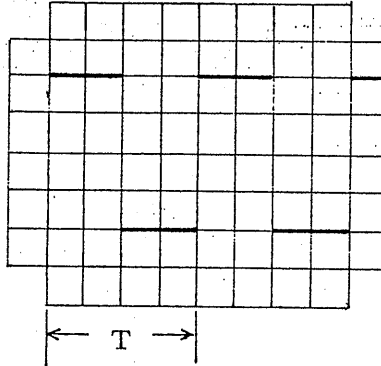

$$\text{Time } T \text{ (sec)} = \text{TIME/DIV (sec)} \times \text{Read distance (DIV)} \times \text{Magnification factor(A)}$$

Magnification factor is 1 when it is idle, and is 1/5 when it is affected.

5.2 Pulse Width Measurement

Set the measured pulse signal in the center of the screen, with an easily readable horizontal amplitude of 2 ~ 4 DIV.

Turn the variable control of the TIME/DIV to the CAL'D position.

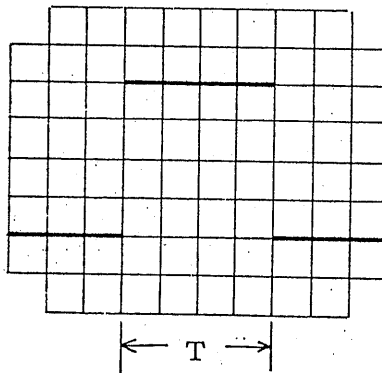

When the pulse width is narrow, effect the 5x MAG function as required. Determine the distance of 'T' and calculate the time interval using equation (A).

772554

DL

5.3 Measurement of Pulse Rise Time and Fall Time

In a similar manner as pulse width measurement, determine the distance 'T' and calculate rise or fall time using equation (A). When the rise or fall time of the measured signal is sufficiently slow as compared with that of the MODEL 5516DL itself (17.5ns), the value can be directly read. When that of the measured signal is fast, the measured value must be corrected employing the below formula.

$$T_n = \sqrt{T^2 - T_o^2 - T_G^2}$$

T_n : True value

T : Measured value

T_o : Rise time of the MODEL 5516DL, 17.5ns
(Calculated value)

T_G : Rise time of square wave generator

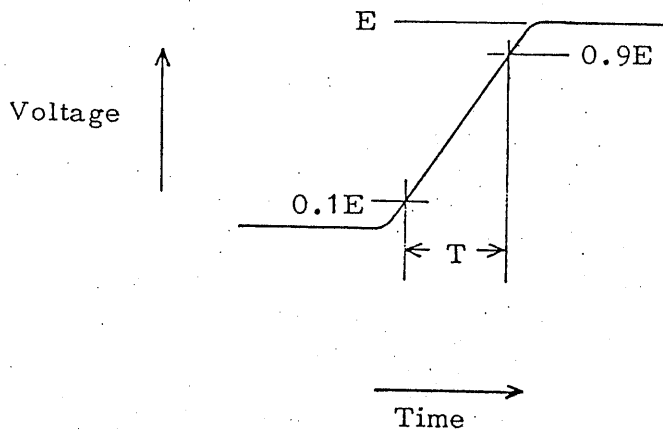

5.4 Frequency Measurement

There are three frequency measuring methods as below.

- (1) The period per one cycle of waveform is calculated employing equation (A) upon determining the time interval 'T', and the frequency is calculated as the reciprocal of the period.

$$\text{Frequency } f \text{ (Hz)} = \frac{1}{\text{Period } T \text{ (sec)}}$$

- (2) The time interval per 10 ~ 20 cycles is determined, the number cycles per 10 DIV of graticule is counted, and the frequency is calculated with the below formula.

$$\text{Frequency } f \text{ (Hz)} = \frac{N}{\text{TIME/DIV indication (sec)} \times 10}$$

This method is advantageous over method (1) in that measuring errors are reduced as the number (N) of cycle is increased.

- (3) In the above two methods, the frequency is measured through measuring the period. When the signal is less than 10kHz and is of a sine or other simple waveform, frequency measurement can be efficiently made by operating the oscilloscope in the X-Y mode, and displaying a Lissajou's figure.

For the operation method, refer to paragraph 4.3 X-Y mode.

Connection for frequency measurement

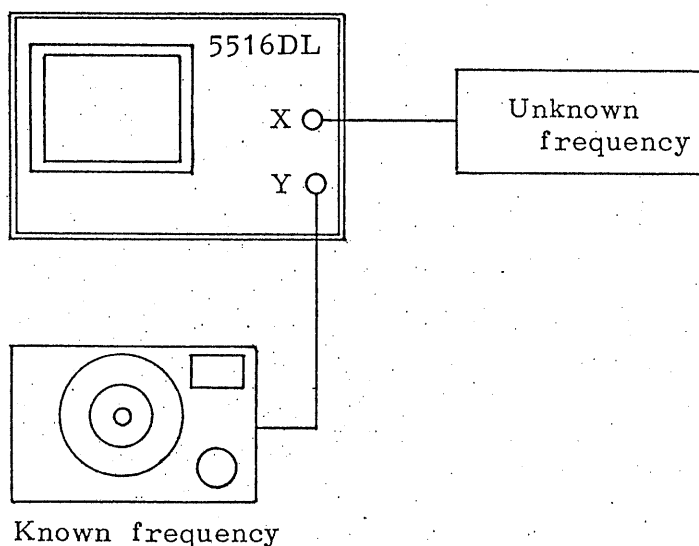

Adjust the sensitivities with the VOLTS/DIV switch and the variable control in accordance with the levels of the signals applied to the X axis and Y axis, so that the amplitudes are made almost equal for both axes. As signal of the known frequency source is varied, a Lissajou's figure representing 1:1 as illustrated below is displayed on the CRT screen.

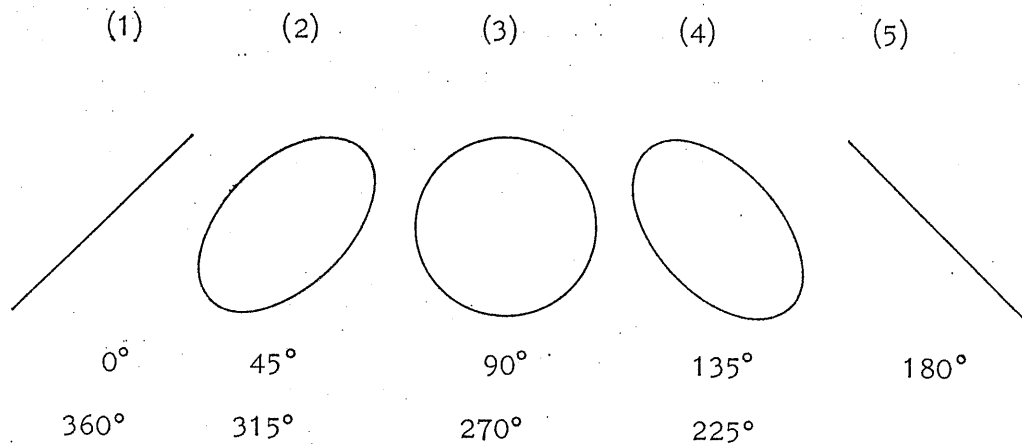

The Lissajou's figure which represents the frequency ratio of 1:1 is either a circle, an ellipse, or a line. When the frequency ratio approaches 1:1, the figure continuously rotates in the order of (1) (5) (1).

As the frequency ratio approaches still closer to 1:1, the rotation becomes slower and, ultimately, when the two signals frequencies have become exactly equal, the Lissajou's figure becomes stationary.

Now the unknown frequency is determined to be the same with the known frequency. This method using a Lissajou's figure representing 1:1 is the most simple but accurate method of frequency measurement, provided a continuously variable wide-range reliable signal generator is available.

770EE7

DL

5.5 Phase Difference Measurement

1) Phase Difference Measurement with Lissajou's Figure

Operate the MODEL 5516DL in the X-Y mode and display a Lissajou's figure as described in the paragraphs for frequency measurement.

In the case, the both X axis and Y axis amplifiers should be operated at their maximum sensitivities . Adjust the output of the signal source so that the amplitude of the displayed waveform is made more than a half of the screen in the center of the CRT screen. Determine the distances A and B on the graticule, and calculate the phase difference employing the below formula.

$$\text{Phase difference } \theta = \text{Sin}^{-1} \frac{A}{B}$$

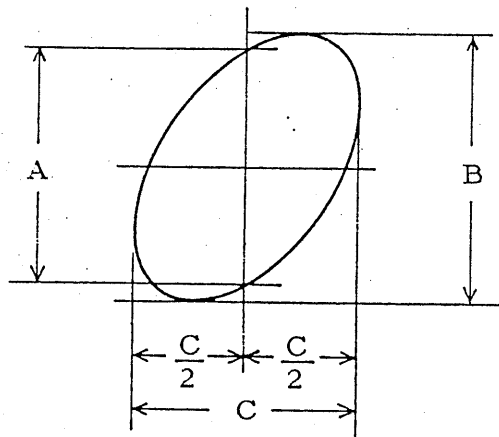

Disadvantages of phase difference measurement with Lissajou's figure are as follows:

- (1) With a conventional oscilloscope, the frequency response of X axis is not sufficiently wide and substantial phase shift is caused within the oscilloscope.
- (2) The measuring accuracy of phase difference is not very high.

For the above reasons, the below-described dual channel method is recommended for accurate measurement of phase difference.

2) Phase Difference Measurement in Dual Channel Method

Set the MODE selector of the vertical axis in the DUAL state, and depress the CH1 button of the trigger selector. Apply signals to the CH1 and CH2 channels (the reference signal to the CH1), and display waveform as illustrated below.

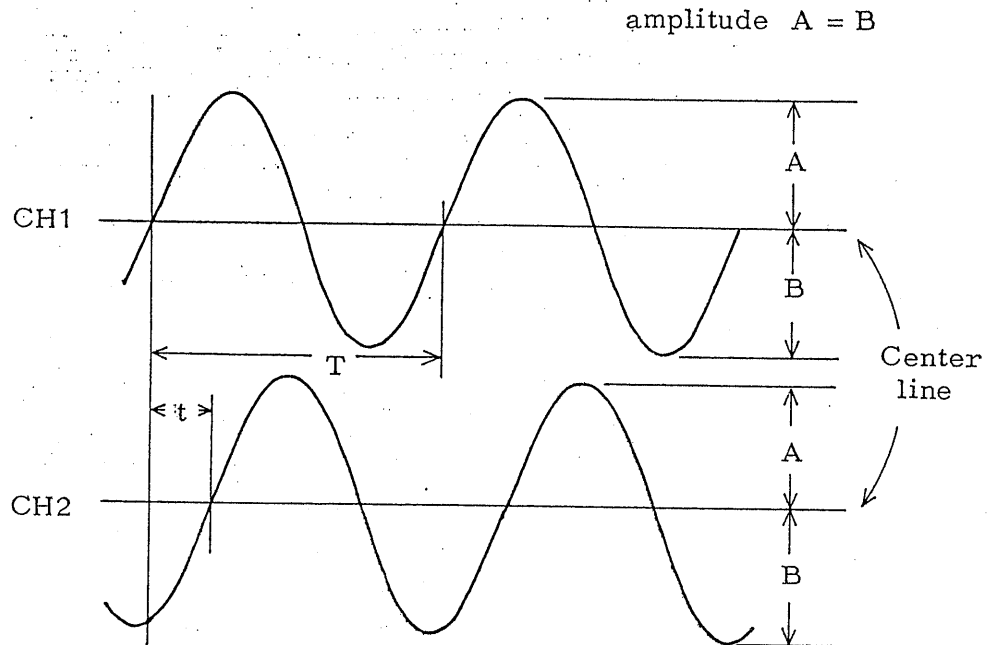

$$\text{Phase difference } \theta^\circ = \frac{t}{T} \times 360^\circ$$

Measure the phase difference with large amplitudes of displayed waveforms, by increasing the sensitivities of both channels.

As for the center lines of waveforms, set both the CH1 and CH2 in amplitudes A = B .

Then probes are to be used for measurement, use them for both channels and accurately adjust their phase characteristics employing the CALIB signal.

The dual-channel phase difference 't' can be measured and the leading or lagging state can be known at a glance.

779550

DL

6. CALIBRATION

6.1 General

The MODEL 5516DL should be calibrated periodically. The calibration should be recomendably cover all items. However, calibration on special items may be made instead, for example, the time axis may be calibrated especially if the use of the oscilloscope is primarily for time measurement or the vertical sensitivity may be calibrated with extra attention if the routine measurements require accurate vertical sensitivity.

The overall items must be calibrated after the MODEL 5516DL has been subjected to repair which affects the essential performance of the oscilloscope or after the DC power supply (regulated or unregulated) has been adjusted or repaired.

For reliable calibration, please contact Kikusui's agent in your area.

Calibration points and methods which can be made comparatively easily are explained below.

6.2 Adjustment and Check of DC Power Supply

Before calibrating the MODEL 5516DL, the DC voltage supply must be inspected and adjusted. An accurately calibrated digital voltmeter is recommended for the inspection and adjustment. The voltages and semi-fixed resistors for adjustments are listed in the below table and the locations of these components are shown in the below drawings.

DC power supply	Type	Voltage tolerance	Resistor	Remarks
+5 V	Regulated	+4.75V ~ +5.25V	Non-adjustment	
+15V	" "	+14.9V ~ +15.1V	VR1403	⊗
-15V	" "	-14.7V ~ -15.3V	Non-adjustment	
+205V	Non-regulated	± 20%	-	
+280V	" "	± 20%	-	
-1850V	Regulated	-1845V ~ 1855V	VR1301	⊗

Each voltage must be measured between the check point and the ground. The input power voltage in this case must be maintained within $\pm 5\%$ of the primary supply.

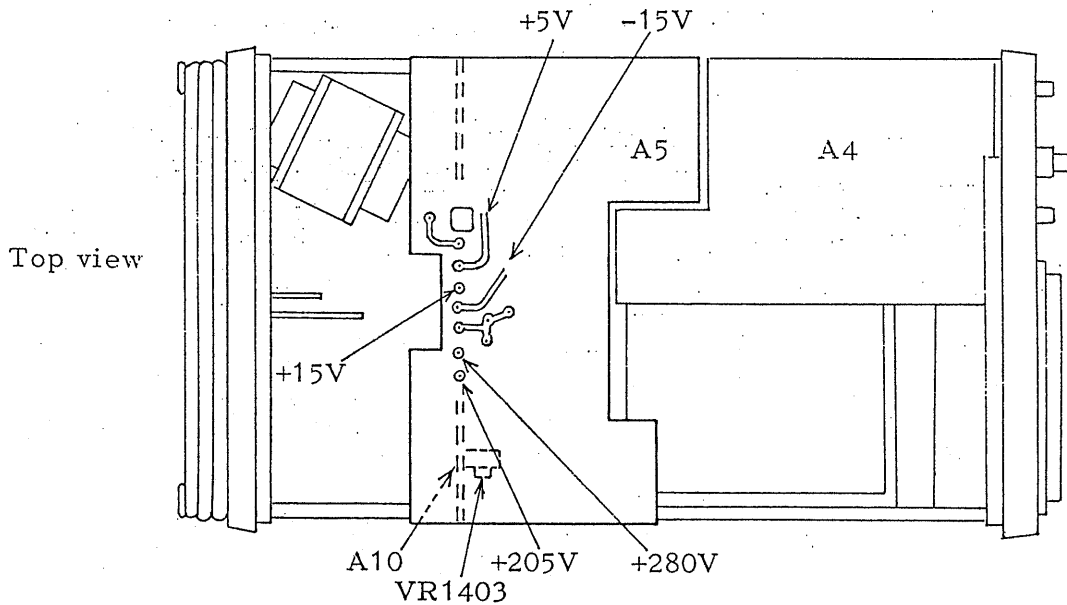

-1850V DC power supply is applied to CRT. This voltage must be carefully checked because the trace intensity and the vertical and horizontal deflection sensitivities are largely affected. The check point is PIN #14 of CRT.

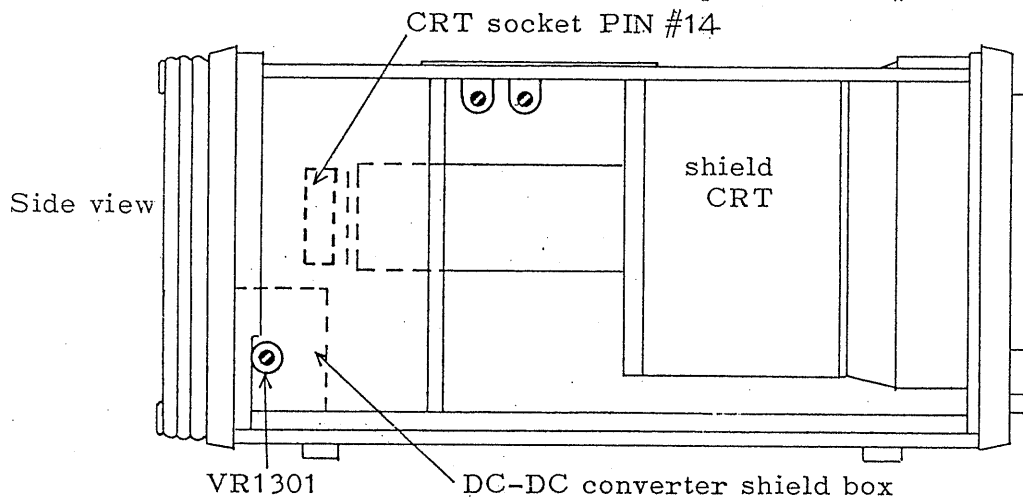

Note : Check and adjust each DC power supply in order of the following procedure.

1. +5V voltage check
2. +15V voltage adjustment
3. -15V voltage check
4. +205V voltage check
5. +280V voltage check
6. -1850V voltage adjustment

Use of a precision digital voltmeter with high input resistance more than $1000M\Omega$ is recommended for measuring -1850V.

6.3 Vertical Deflection Sensitivity

Apply the output signal of the square wave generator which has an output voltage accuracy of better than 0.5%, at 1kHz, 40mVp-p, to the vertical input terminal. Set the VOLTS/DIV in the 5mV position, and adjust the CAL semi-fixed resistor (CH1 - VR305, CH2 - VR405) on the panel so that the displayed square wave amplitude is accurately 8 DIV on the graticule.

At each range of the VOLTS/DIV, apply an input voltage corresponding to 8 times of the value indicated by the VOLTS/DIV switch, and measure the amplitude of the displayed square wave.

At any range, the measured value must be within $\pm 3\%$ of the value indicated by the VOLTS/DIV switch.

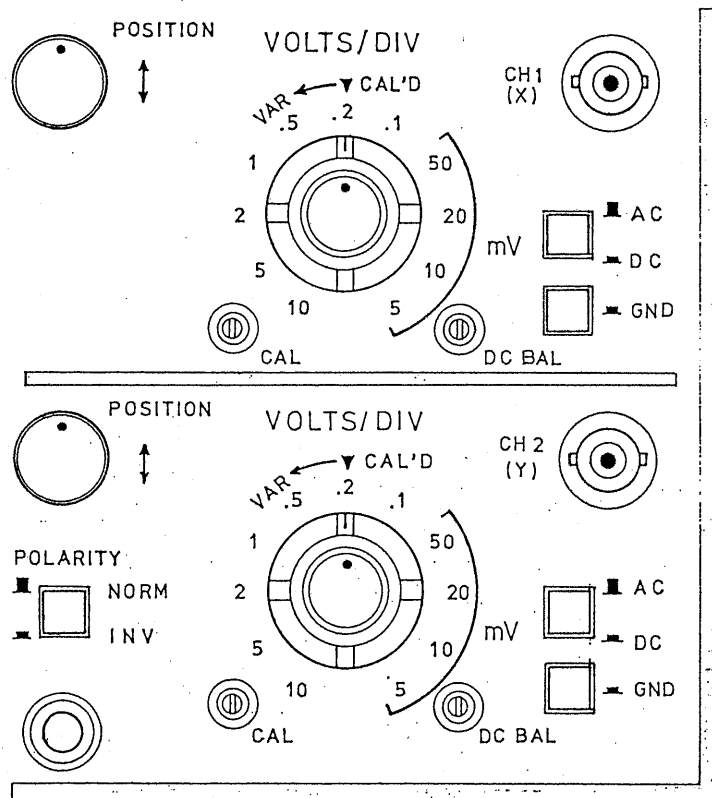

70

6.4 VOLTS/DIV Input Capacitance and Phase Characteristics Compensation

Unless the phase characteristics of each range of the VOLTS/DIV switch is correctly adjusted, the waveform displayed on the CRT screen may be distorted and the frequency response may become abnormal.

Adjustment of the phase characteristics is made by adjusting the input capacitor and the compensation capacitor. For this adjustment, a capacitance meter which is capable of measurement of the input capacitance (35pF) and highly reliable square wave generator which is capable of providing a quality square wave of a repetition frequency of approximately 1 kHz are required.

As for the capacitance meter , conventional bridge-type meter is inadequate. A low-capacitance C meter should be used. As for the 1 kHz square wave generator, the internal generator of the MODEL 5516DL which provides the CALIB signal for the probes can be used. If an external square wave generator is to be used, the generator must be capable of delivering a signal of quality waveform with minimum overshoot and sag and with rise time of less than 1 μ s.

The adjusting points are tabulated below.

Range of VOLTS/DIV	CH1		CH2	
	Variable capacitor for calibration		Variable capacitor for calibration	
	Input Capacitor	High frequency compensation	Input Capacitor	High frequency compensation
5mV	C114	-	C214	-
10mV	C109	C108	C209	C208
20mV	C112	C111	C212	C211
50mV	C102	C103	C202	C203
0.1V	-	-	-	-
0.2V	-	-	-	-
0.5V	C106	C105	C206	C205
1 V	-	-	-	-
2 V	-	-	-	-
5 V	-	-	-	-
10 V	-	-	-	-

Mark - represents no adjustment.

The location of the adjusting capacitor is shown in below figure.

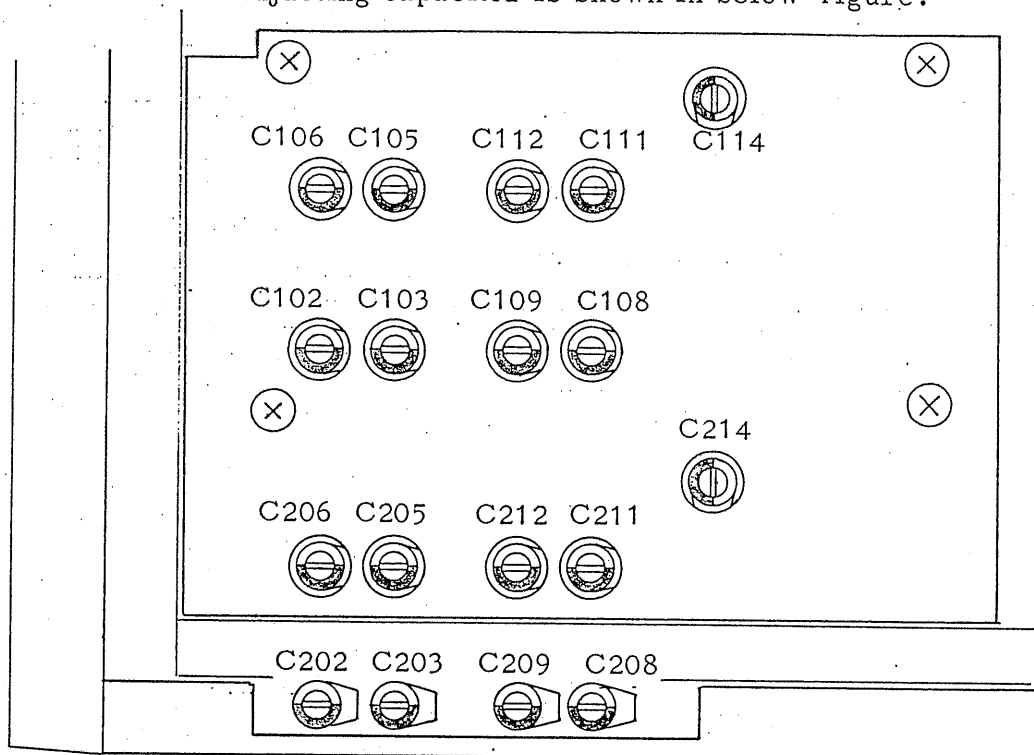

6.5 Sweep time

Set the knobs on the front panel as below. Apply an accurate 1ms interval time marker signal or an accurate 1kHz signal to the vertical input.

Trigger mode	AUTO
TIME/DIV	1 ms

The specified accuracy of sweep time is within $\pm 3\%$ of the value indicated by the TIME/DIV switch. The 1ms range is the reference range for all other ranges and, therefore, this range must be calibrated especially accurately. Adjust the SWEEP CAL x 1 (VR101 on the block diagram) semi-fixed resistor so that the calibration is made to an accuracy of $\pm 1\%$.

Calibrate the 5 x MAG mode of operation to an accuracy of $\pm 1\%$ by means of the MAG ADJ semi-fixed resistor (VR102).

The adjusting semi-fixed resistor location is shown in the following figure.

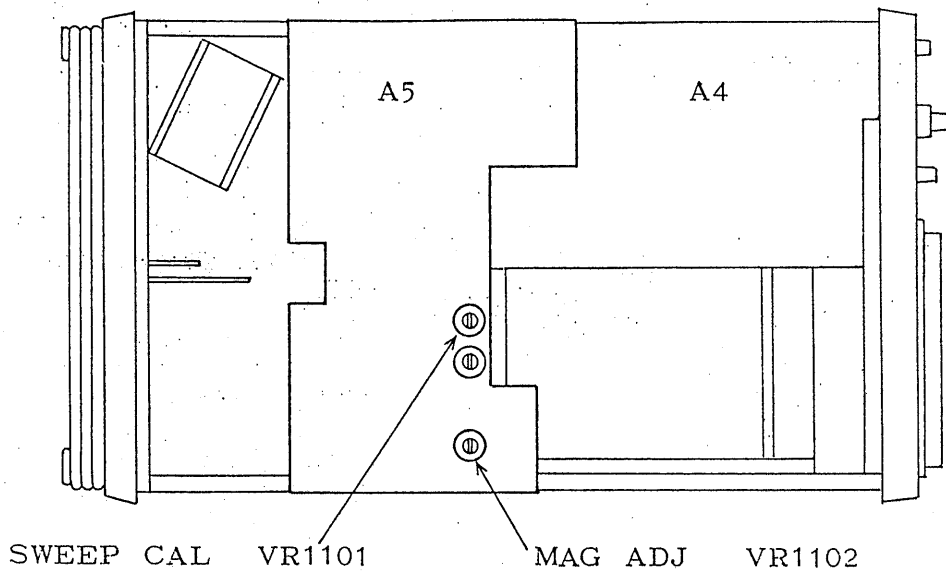

6.6 Calibration of Probe

To calibrate the probe, use the calibration signal of 1kHz, 50mVp-p or 2Vp-p available on the CALIB terminal on the front panel.

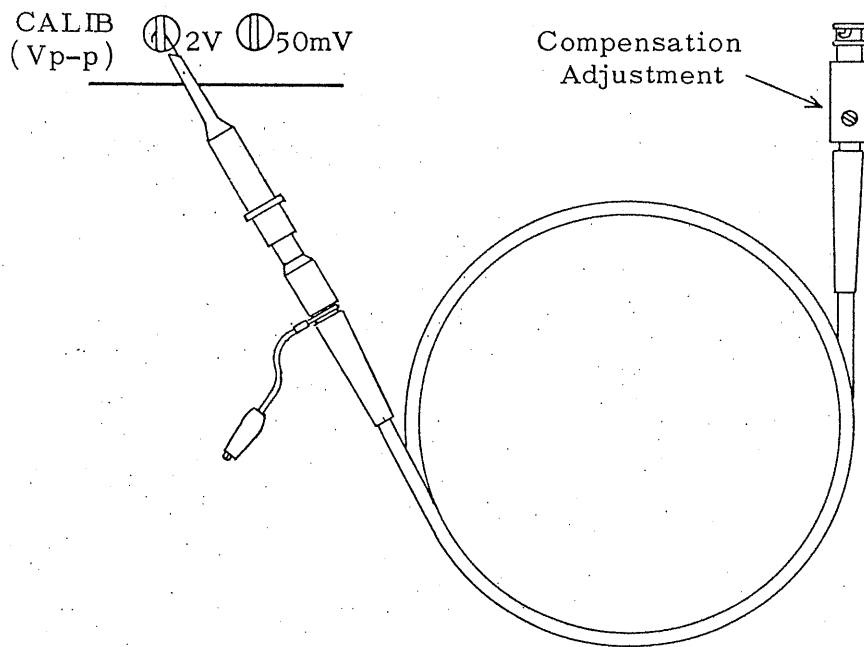

772565
772565

Connect the probe to the CH1 or CH2 input terminal. Set the range at 50mV. When the probe tip is contacted to the CALIB terminal where 2Vp-p voltage is being delivered, a square wave with an amplitude of approximately 4 DIV should be displayed on the CRT screen.

Turn the compensator with a screwdriver so that an optimum waveform as illustrated below is obtained.

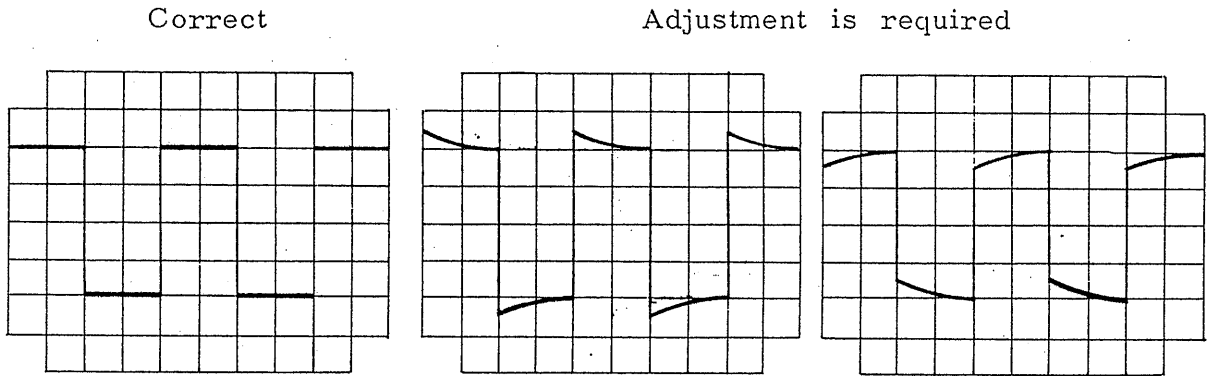

6.7 Adjustment of ASTIG and GEOMETRY

ASTIG In conjunction with the FOCUS control on the front panel, adjust the ASTIG control so that the well-defined spot or trace is displayed on the CRT screen.

GEOMETRY Adjust the GEOMETRY control to compensate for distortion of rectangular raster area displayed on the CRT screen.

The locations of semi-fixed resistor are shown below.

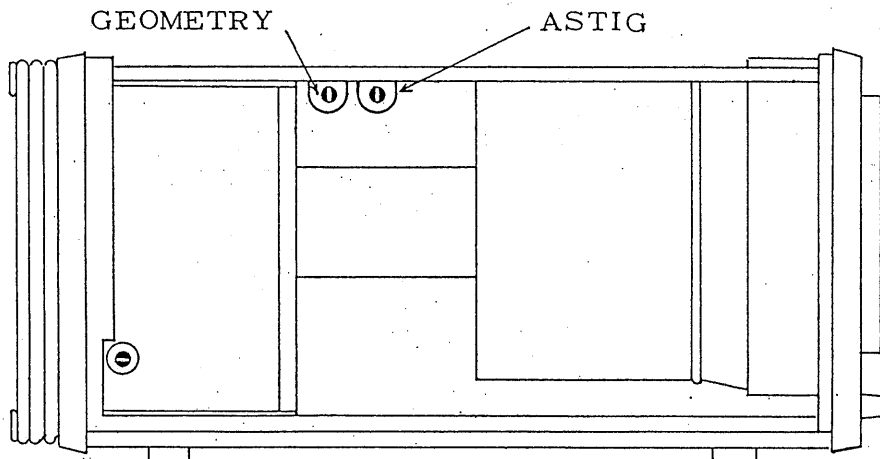

772566

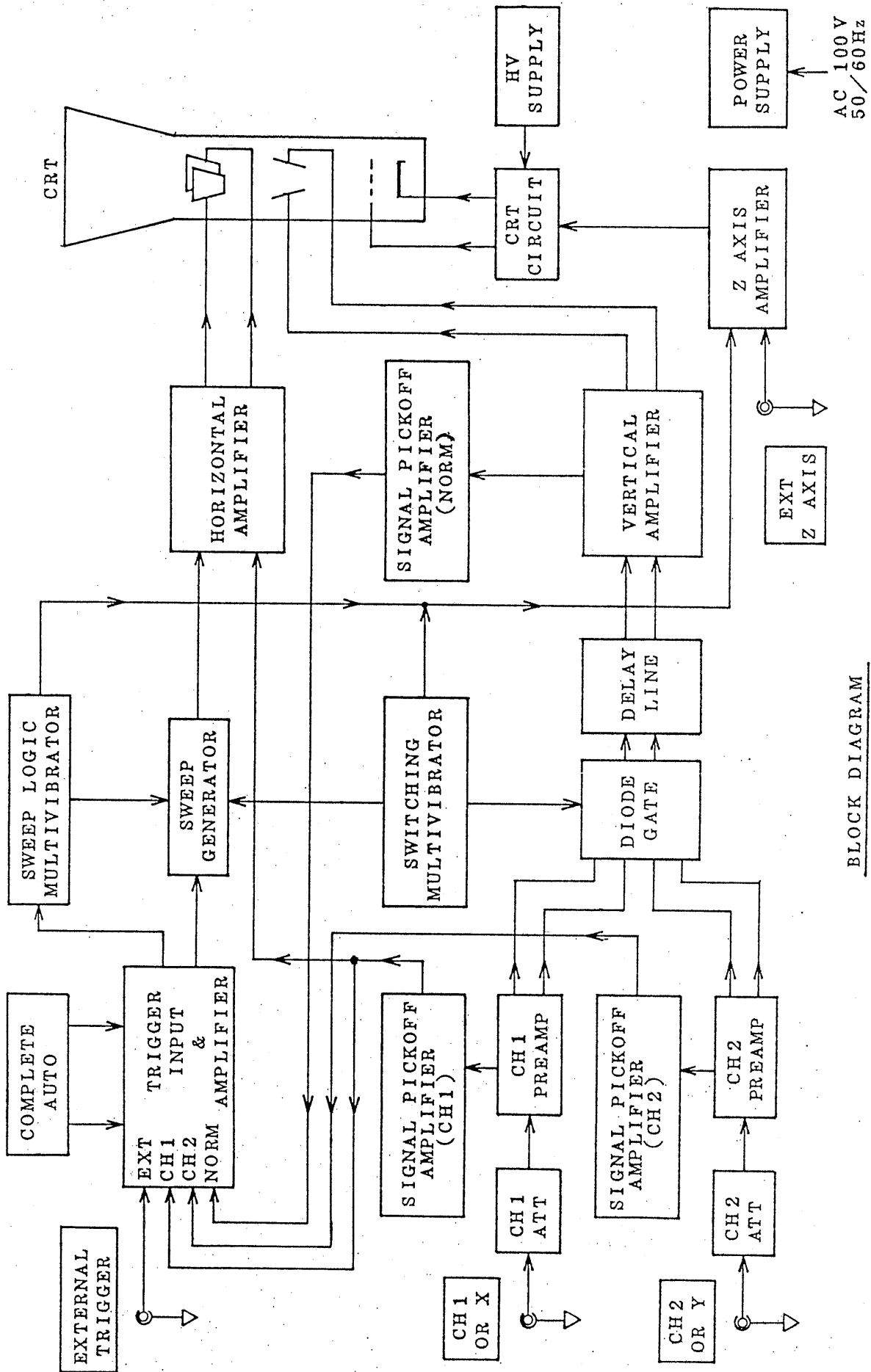

BLOCK DIAGRAM

779567